

Zawias hydrauliczny ECHC 3D Hydraulic cup hinge ECHC 3D Гидравлическая петля ECHC 3D

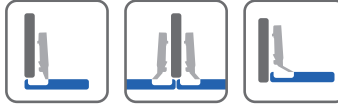

ZASTOSOWANIE / APPLICATION / ПРИМЕНЕНИЕ



PARAMETRY / CHARACTERISTICS / ХАРАКТЕРИСТИКИ

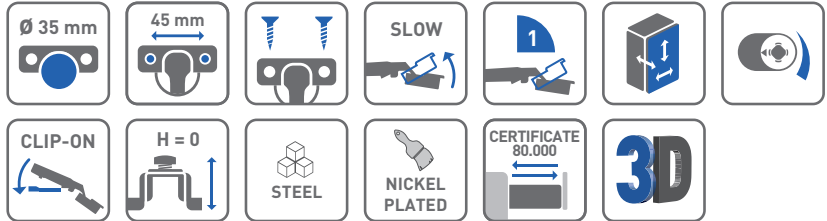

OPCJE ZESTAWU / SET OPTIONS / КОМПЛЕКТАЦИЯ



PAKOWANIE / PACKING / УПАКОВКА



SKŁAD ZESTAWU / SET INCLUDES / КОМПЛЕКТАЦИЯ

ZAWIAS NAKŁADANY
OVERLAY DOOR
НАКЛАДНАЯ ПЕТЛЯ

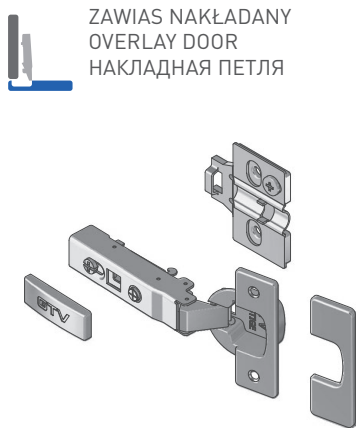

HO	ZM-ECHC09-3DBE0	x4	—

ZAWIAS BLIŹNIACZY
TWIN OVERLAY DOOR
ПОЛУНАКЛАДНАЯ ПЕТЛЯ

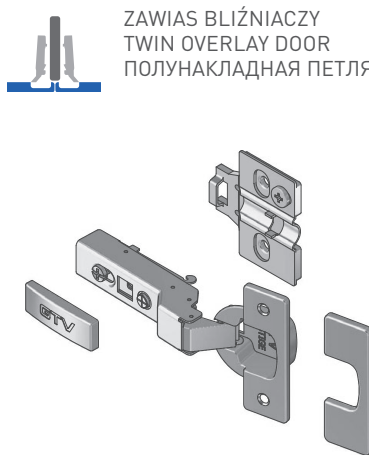

HO	ZM-ECHC08-3DBE0	x4	—

ZAWIAS WPUSZCZANY
INSET DOOR
ВКЛАДНАЯ ПЕТЛЯ

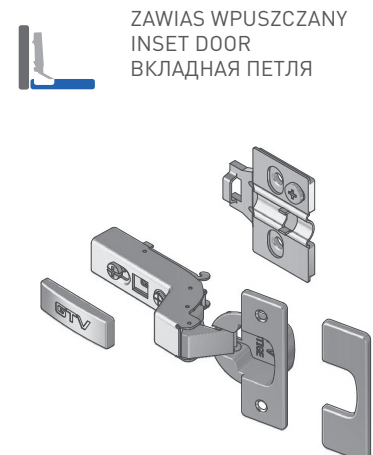

HO	ZM-ECHC07-3DBE0	x4	—

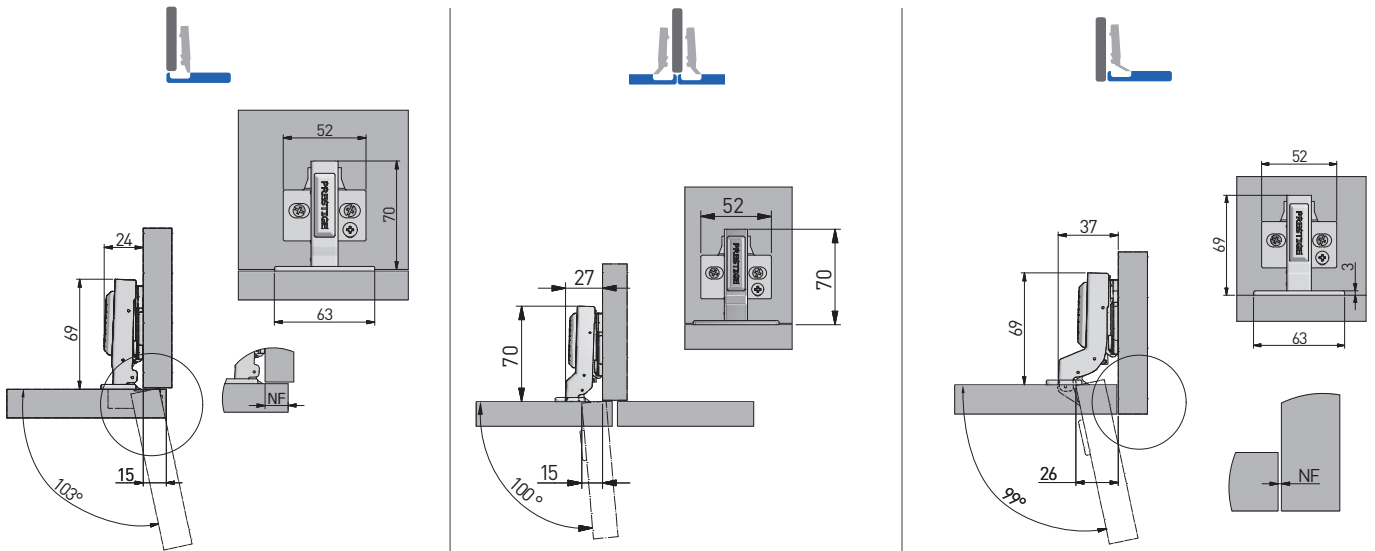

MONTAŻ / MOUNTING / МОНТАЖ

montaż prowadnika w korpusie
mounting plate installation
присадка под ответную планку

montaż puszki we froncie
hinge cup installation
присадка под чашку петли

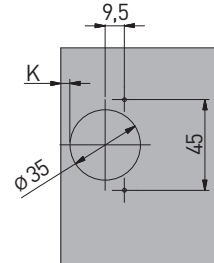
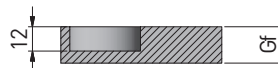
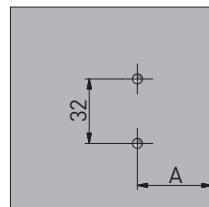
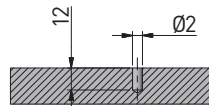

Gf = min. 16 mm
- max. 18 mm

A = 37	A = 37	A = 37 + Gf

NF	14	15	16	17	18	3	4	5	6	7	-5	-4	-3	-2	-1
H = 0	K		3	4	5			3	4	5			3	4	5

A = odległość prowadnika od krawędzi (mm)
gap between mounting plate
and the cabinet edge (mm)
расстояние от ответной планки
до края (мм)

NF = natożenie frontu (mm)
front overlay (mm)
наложение фасада (мм)

H = wysokość prowadnika
mounting plate height
высота ответной планки

K = odległość puszki od krawędzi (mm)
gap between hinge cup and cabinet edge (mm)
расстояние от чашки петли до края (мм)

Gf = grubość frontu
front thickness
толщина фасада

REGULACJA / ADJUSTMENT / РЕГУЛИРОВКА



± 2 mm



± 1,5 mm



± 1,5 mm